

Article number: 20597044

Description: E+G Levelling foot
GN 339-36-M10-45-KR-ST

Measures

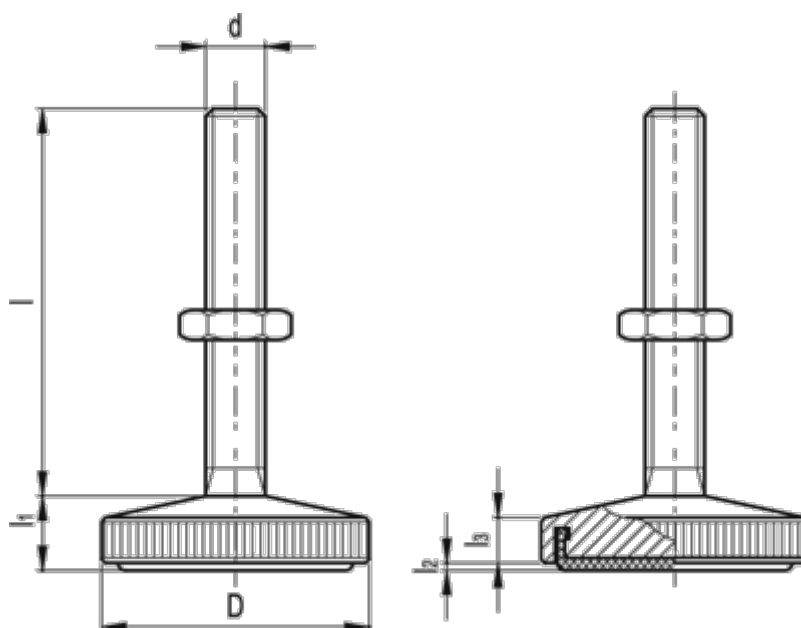

d	= M10
D	= 36
l	= 45
l1 approx.	= 9
l2	= 0.5
l3 approx.	= 6